

HomeHandy Pico

Operating instructions

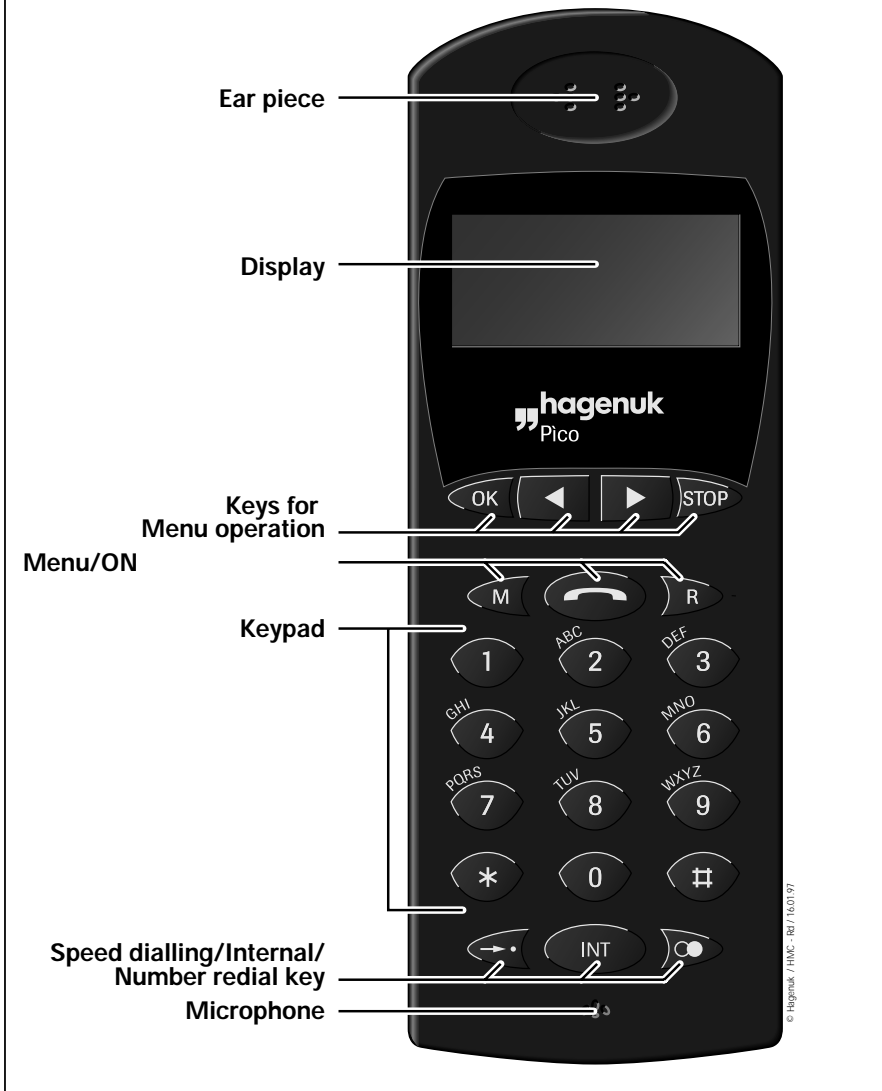

The handset



The base station

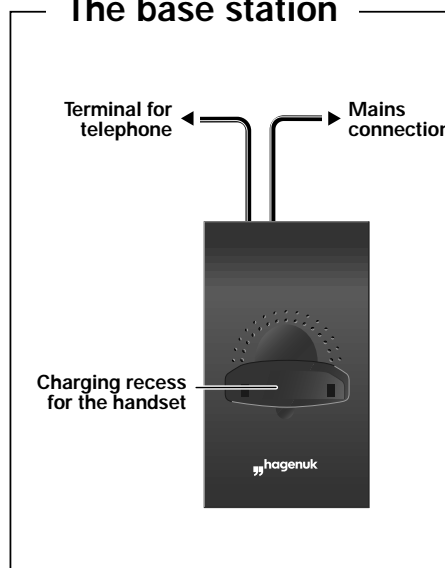

The technology at a glance

- The enhanced-feature handset for DECT base stations and systems with GAP
- Digital transmission in accordance with the DECT standard
- Speed dialling memory for 21 phone numbers
- Adjustable handset volume
- Choice of standard NiCad or NiMH batteries of various capacities (size AA / "Mignon")

Table of contents

1	Getting acquainted with and connecting the HomeHandy Pico	3
1.1	Introduction	3
1.2	Getting started	4
1.3	Charging and handling of the batteries	5
1.4	Inserting/replacing batteries	6
1.5	Settings upon delivery	6
2	Operating overview	7
2.1	Operating overview	7
2.2	Operator guidance	8
2.3	Entering names and text	9
2.4	Displays - standby mode	11
2.5	Displays - ready-to-dial mode	11
2.6	Displays - standby mode: dial preparation	12
3	Basic functions: phoning	13
3.1	Switching on and dialling (external call)	13
3.2	En-bloc dialling (external call)	13
3.3	Switching on and dialling (internal call)	14
3.4	Terminating the call (internal and external calls)	14
3.5	Taking a call (incoming calls)	14
4	Further functions	15
4.1	Number redial - history function	15
4.2	Speed dialling - general	16
4.3	Storing names and phone numbers	16
4.4	SOS number	17
4.5	Deleting the speed dialling memory	18
4.6	Speed dialling	19
4.7	SOS number (emergency phone number) - making an emergency call	20
4.8	Muting	20
4.9	Switching on/off of the handset	21
4.10	Temporary switching off of the handset	21
4.11	Activating the keyboard lock	21
4.12	Deactivating the keyboard lock	21
4.13	Activating the handset lock/changing the PIN	22
4.14	Phoning with active handset lock	22
4.15	Deactivating the handset lock	23
4.16	Call duration display	23
4.17	Temporary (intermittent) changeover of the signalling method	23
4.18	Changing the PIN(personal identification number) of the base	24

Table of contents (cont.)

5	Settings/programming	25
5.1	Activating/deactivating the key click	25
5.2	Setting the ringer	25
5.3	Increasing the handset volume	26
5.4	Resetting the handset volume to the standard volume	26
6	Operating several handsets / several base stations	27
6.1	Measuring the field strength.....	27
6.2	Selecting a base station	27
6.3	Logging a handset into a base station.....	28
6.4	Logging in an additional handset (Multilink)	29
6.5	Logging off a handset (Multilink).....	29
6.6	Consultation hold / extending calls to another handset (Multilink).....	30
7	Operation on a telephone system	31
7.1	Setting the signalling method and the dial pauses	31
7.2	Extending a call/consultation hold within a telephone system	31
8	Using other makes of handset	32
8.1	General information	32
	Pictograms on the display	33
	Cleaning and care / Technical data	34
	Faults and remedies	35
	Index	36
	Approval and CE label	37
	Overview of menu items	40

1.1 Introduction

The HomeHandy Pico is a cordless telephone in line with the DECT-GAP standard.

It consists of a handset and a base station in which a charging facility for the batteries is integrated. Additional charging facilities (chargers) are available as an accessory.

In addition to the voice encryption stipulated in the DECT standard, speech is encrypted in the handset and the base station; this provides you with an effective protection against the tapping of radiophony traffic by third parties using wide-band receivers (scanners). It does not impair the speech quality.

Notes Unpleasant secondary noise can be caused in conjunction with **hearing aids**.

A **call cannot be made** with the HomeHandy Pico during a **power failure** as the power supply to the base station is then interrupted.

The HomeHandy Pico operates according to the **GAP standard**, i.e. other handsets which also comply with the GAP standard can be logged into the Hagenuk base. Likewise, this handset can be logged into other "GAP" bases.

For information on the log-in procedure, please refer to the instructions of the respective manufacturer.

Attention Your HomeHandy Pico has a **personal identification number (PIN)**. On delivery, it is set to "0 0 0 0". If you wish to prevent certain settings (number of logged-in handsets etc.) from being altered by unauthorised persons, then this PIN must be changed. However, please do not forget to make a note of this PIN as the unit can only be reset by a service technician should you forget the PIN.

1.2 Getting started

Selecting the location

The following points should be observed when selecting the location for the HomeHandy Pico base station:

- Do not set it up in close proximity to CD players, video recorders, television sets, computers and microwave ovens. Furthermore, the base station has to be located clear off satellite receivers and answering machines unless these are specifically designed to be DECT-resistant.
- Avoid setting it up in very smoky or dusty conditions. Direct sunlight, damp or locations subject to high humidity are also best avoided, as are locations close to sources of heat.
- Try to locate the base station in the centre of the area from which calls are to be made; in a multi-storey building, the optimal position is to be found near to the staircase.

Use a **non-slip mat** for the base station and charger (accessory) so that the plastic feet are not attacked by the varnish coat of the furniture leaving unpleasant marks on the surface.

Connecting the base station

The base station has to be connected to the **telephone network** and **mains supply** before the HomeHandy Pico can be used. Establish the connections as illustrated in the sketch.

The connection sockets (2 x western) are located on the underside of the base station; they are marked with the corresponding symbols.

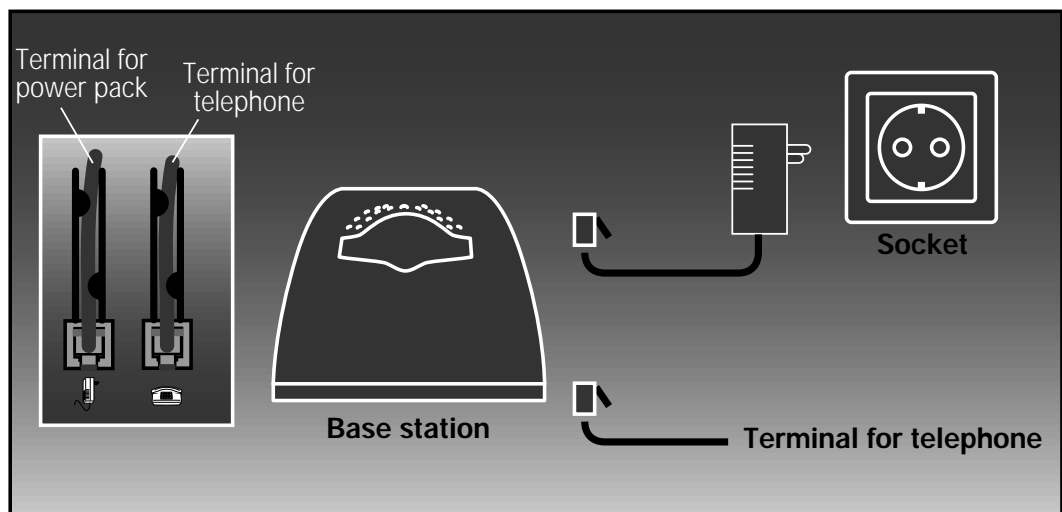

1.3 Charging and handling of the batteries

Charging the batteries

In the case of brand new units or when putting a unit into operation after a longer storage period, the batteries have to be charged first. This is done by placing the handset in the charge unit.

Different types of batteries can be used to operate the handset (e.g. 650 mAh NiCad, 700 mAh NiCad, 1200 mAh NiMH etc.); **however, it is essential that two identical batteries are used!**

The batteries are charged for up to 14 hours during **initial charging**; this is not done constantly, but by means of pulse charges.

The batteries are charged quicker during **normal operation** (i.e. when the handset is placed in the base station after the "Batt. Empty" signal).

The batteries' charge level decreases **during operation**; the display indicates these changes in different steps (100, 80, 70, 60 etc.).

When the batteries are replaced, the capacity is not displayed instantaneously. Even if the batteries are charged, there is an unknown charge state.

The display shows the following: -----%?

The "normal" display showing the percentage only appears after a few hours.

If you cut off the electricity in the house for several hours (e.g. during a

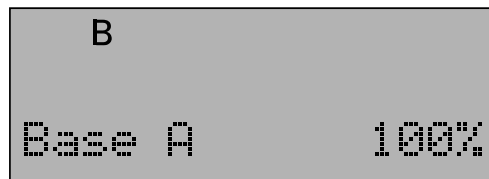

holiday or longer installation work), then you should remove the batteries to avoid excessive discharging.

Battery handling

Thanks to optimised charging based on the calculated consumption, no particular procedure is necessary to ensure long battery life.

Nevertheless, batteries are subject to deterioration over time, their capacity and the respective operating times diminish.

Defective batteries should be taken to a collecting point for batteries; **they should never be thrown away together with domestic rubbish!**

1.4 Inserting/replacing batteries

Remove the cover on the battery compartment by applying moderate pressure to the upper edge where the catch is located. Remove the old batteries if necessary. Insert new batteries as illustrated. Push the cover back on; make sure the catch engages.

The batteries to be inserted must be of the same type and capacity!

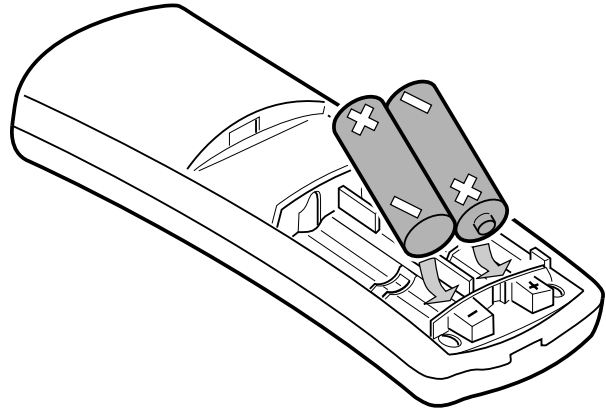

1.5 Settings upon delivery

The HomeHandy Pico is delivered with the following settings:

Handset

- No phone numbers stored
- Ringer melody level 2
- Ringer volume level 5
- Normal handset volume
- Keypad lock inactive
- Key click switched on
- PIN 0 0 0 0 / lock inactive
- Logged in

Base station









- Pulse dialling
 - PIN 0 0 0 0
 - No dialling pause
-

2.1 Operating overview

The keypad

The keypad consists of 22 keys:

- numerical keys **1** to **0** and the special keys ***** and **#**
- the "special" keys for:

	Number redial		Menu key
	Internal (int. connection)		Selection key
	Signal key (consultation hold)		STOP key
	Switch on/off (hook)		Cursor control
	Speed dialling memory		

Time-Out

Incomplete programming procedures or check displays are aborted **30 seconds after the last key depression** (without a change having been stored); this is signalled by the negative confirmation tone.

Confirmation tones

Positive confirmation tone

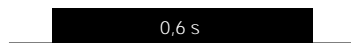

- completion of successful programming procedures
- when logging in additional handsets (refer to 6.2 and 6.3)

Negative confirmation tone

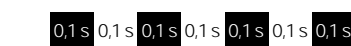

- maloperation
- Battery almost empty (remaining talk time approx. 3 min.)
- all radio channels busy

Ringer tones

Trunk call sequence

- An external call comes in



Internal call



Internal busy tone

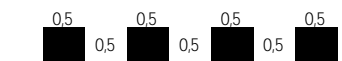

Internal dialling tone



Camp-on tone (in the handset)

When there is an incoming external call during an internal connection



2.2 Operator guidance

Your new telephone eases operation by means of helpful display prompts.

M

Menu key

The menu is activated/quit via the **menu key**.

Which menu items are offered is status-dependent (refer to "Overview of menu items").

The current state of the handset is indicated on the first line of the display by means of pictograms (see pictograms on display). The functions that are currently available are offered in plain text on the first text line. The second text line indicates the corresponding options for these functions by means of texts and abbreviations. You have the following options:

OK

First option: OK key

Confirm selection by pressing the **OK key**. You can now, for example, program a speed dialling memory or change one which has already been programmed.

The **OK key** is generally used to confirm a selection or store an input.

Stop

Second option: Stop key

Terminate menu operation by pressing the **stop key**. Operations can be terminated or inputs aborted at any time by pressing the **stop key**. You then go back to the respective previous menu level or to the standby mode.



Third option: Arrow keys

The arrow keys can be used to "browse" forward (right) or backward (left) in the menu to select a menu item or, for example, an entry.

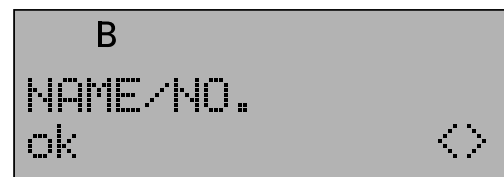
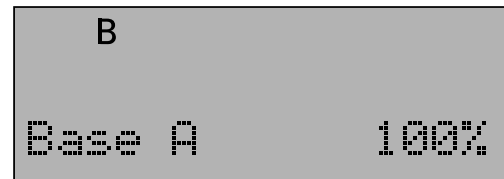

2.3 Entering names and text

The input of characters is possible, when "A-Z" appears on the second line.

Letters, numbers and various punctuation marks (are available as characters.

```

B
01: NAME?
ok      A-Z      ><

```

An input is made via the **numerical keys**. Several characters are allocated to each number and can be found above the keys.

Select character:



- One key depression = first character
- Two key depressions = second character etc.
- The last character is followed by the number of the key, then again by the first character etc.

Character has been selected:

- Press the key for the next character.

If a character on the same key is to be selected again:

- Press the right arrow key and select the character again.

Example: Select characters (characters ABC – number 2)

2	One depression of key "2"	Representation of character "A"
2	Two depressions of key "2"	Representation of character "B"
2	Three depressions of key "2"	Representation of character "C"
2	Four depressions of key "2"	Representation of character "2"
2	Five depressions of key "2"	Representation of character "A"

Key's can comprise up to 13 characters.



Deleting characters: press left **arrow key**.



Press right **arrow key**. Cursor moves one position to the right: Select **next character**. A **blank** is generated by pressing the **arrow key** again.

```

      B
01: AN_
ok      A-Z  <>
  
```

```

      B
01: ANNE _
ok      A-Z  <>
  
```

Example: Enter name ("ANNE")

2

Numerical key 2 once for "A"

```

      B
A
  
```

6

Numerical key 6 twice for "N"

When a character assigned to the same key is to be selected again, press right arrow key to move the cursor one space forward and proceed as usual.

```

AN
  
```



6

Numerical key 6 twice for "N"

```

ANN
  
```

3

Numerical key 3 twice for "E"

```

ANNE
  
```

2.4 Displays: standby mode



The "**standby mode**" is defined as follows:

The handset is **ready for use**.

There is no radio link to the base station. No call is signalled.

The selected base (A, B ...) and the current battery capacity are displayed on the second line. Battery capacity is stated in increments of 20% or 10%.

```

B
Base A      100%
  
```

If the handset detects a **battery charge of 0%**, the display reads "**NO POWER**" accompanied by an **alert tone**; it is no longer possible to set up a connection.

However, if a radio link exists at this moment, there is a residual operating time of approx. 3 minutes.

```

B
NO POWER!
  
```

A short **alert tone** is given when the handset is placed in the base station. Charging is commenced and "**POWER**" appears on the display as the batteries did not have the full capacity.

```

B
POWER
Base A      80%
  
```

A message is shown on the display if the **field strength is insufficient**, i.e. the handset is **outside the range** of the base or it is **not logged into any base**.

```

No Base     100%
  
```

2.5 Displays: ready-to-dial mode



The "**ready-to-dial**" mode is defined as follows:

The handset has been switched on via the **ON/OFF key**; a **radio link exists to the base station**.

The telephone is ready to dial a phone number. Various options are shown on the second line of the display. You can then, for example, dial a phone number from the **number redial memory** (☎) or from a **speed dialing memory** (☎).

2.6 Displays - standby mode: dial preparation

The "**dial preparation**" state is defined as follows: the handset is in **standby mode**; there is no radio link to the base.



A phone number can now be entered via the **keypad** (up to 24 digits); a phone number which has been stored in the **number redial memory** (refer to chapter 4.1 „Number redial - history function“) or in a **speed dialing memory** (refer to chapter 4.6 „Speed dialling“) can be retrieved by pressing the respective key and is then indicated on the display.

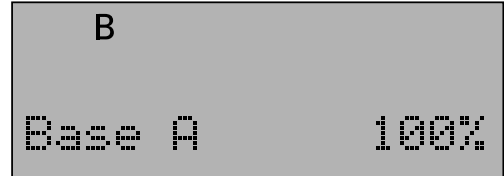

Corrections can also be made subsequently by supplementing digits or deleting the number from the end by means of the **left arrow key** and replacing it with the correct digits.

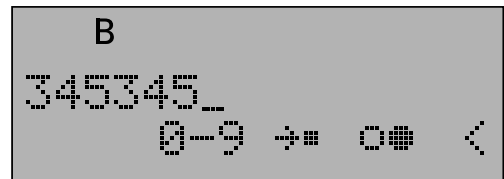

A radio link is automatically established by pressing the **ON/OFF key** and the number is dialled.

3.1 Switching on and dialling (external call)



The handset is in standby mode:



Press the "ON/OFF" key.



Enter the phone number, every digit entered is dialled immediately.

Make the call.
The call duration is displayed after the first minute has elapsed (external calls only).
Metering of the call duration begins 10 seconds after the last key depression.

B
Base A 100%

B
1234
0-9 →* 0# <

B
1234
1:20

3.2 En-bloc dialling (external call)

The phone number can be entered when the handset is in standby mode; the radio link is established by then pressing the "ON/OFF" key and the number is dialled "en-bloc".



Enter the phone number.



Press the **ON/OFF** key.



Make the call.

A phone number that has been dialled is stored in the number redial memory after switching off the handset.

B
0431987654_
0-9 →* 0# <

B
0431987654
1:20

Display of the call duration in minutes/seconds after the first minute has elapsed.

3.3 Switching on and dialling (internal call)

If several handsets (up to 8) are operated on one base station, free internal calls can be made between two handsets. The call duration is not displayed.

The handset is in standby mode:

INT



Press the "INT" key.
Internal number of handset is shown in display.
Enter the number of the handset to be called. Make the call.

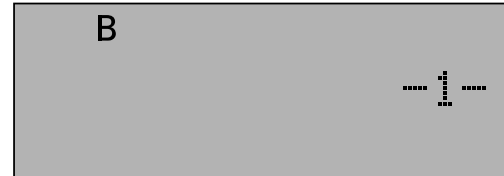

3.4 Terminating a call (internal and external calls)



Press the **ON/OFF** key
or
Place the handset in the base station.

3.5 Taking a call (incoming calls)



When you receive a call:

You hear the ringer; the following messages appear on the display:

Examples:

ON/OFF key does not function for three seconds to prevent inadvertent

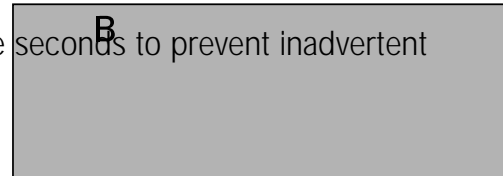

- Call from another handset (No.3) from the same base.

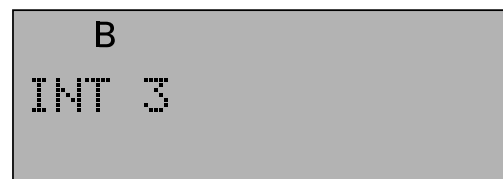

Taking the call

- by lifting the handset from the base station (**automatic connection**)
- or
- by pressing the **ON/OFF** key.

Alternative

The handset is in a charge unit

The handset is in a charge unit when there is an incoming call. It only has to be removed from there, the connection is automatically made and the call can proceed.

The termination of the call.

4.1 Number redial - history function

Phone numbers which are to be dialled again do not have to be repeatedly entered manually. The number can be dialled automatically at the press of a button using the number redial function.

The number redial function automatically recovers **the last 5 phone numbers dialled = history function**.

These phone numbers can be viewed on the display and one of them can be activated to be dialled again.

The last phone number dialled deletes the oldest entry in the number redial memory.

The handset is in standby or ready-to-dial mode:



One depression of the **number redial key**:

The last phone number dialled is displayed.

Corrections or suffixes are possible (also refer to "General information concerning operation: displays when phoning").

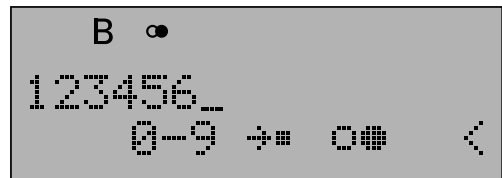

Two depressions of the **number redial key**:

The penultimate phone number dialled is displayed etc.

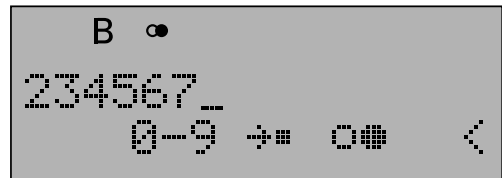

Standby mode:

The number is dialled after pressing the **ON/OFF key**

or

Ready-to-dial mode:

The number is dialled by pressing the **OK key**.

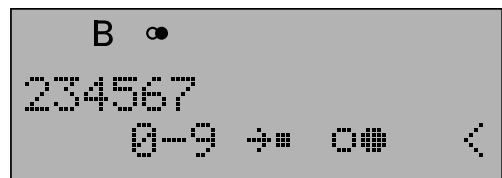

In the case of phone numbers with more than 15 digits, only the last 15 digits are displayed. It is possible to correct or supplement the number as if dialling manually (as described in chapter 2.6).

The phone numbers in the number redial memory are retained even when replacing the batteries.

4.2 Speed dialling - general

The handset has 21 memories for entering phone numbers and names. Entries are chosen by "browsing" with the arrow keys or by entering the respective memory location number (01...21).

As a special feature, you have the option of giving your handset its own name (up to 13 characters) which is shown on the top line of the display when it is in standby mode. This name must be stored in speed dialling location "21".

B
JOE BLOGGS
Base A 100%

4.3 Storing names and phone numbers

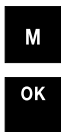

Press **menu key**.



Press **OK key**.



Select "**NAME/NO.**".



Press **OK key**.



Press **OK key**.



Select memory location:



The first memory location is displayed. An empty memory location or one which is to be overwritten can now be chosen by entering a **two digit memory location** number or with the aid of the **arrow keys**. If the memory location is not occupied, then " appears on the top text line of the display.



Press **OK key**.



Enter name; for further details, refer to chapter 2.3 "Entering names and text."



Terminate input of the name by pressing the **OK key**.

```
B  →
05: NAME?
ok  A-Z ><
```

```
B  →
TEL. --NO.?
ok  0-9 P? o? <
```



Enter phone number.

or



Press the **number redial key**.



The **left arrow key** can be used to make corrections.

Press the **number redial key** to store the phone number last dialled.



Press **OK key**.



Choose the next memory location or exit this mode by pressing the **menu key**.

Note:

If a dial pause is to be programmed, this is done by pressing the **speed dialling key** ****** at the appropriate point.

4.4 SOS - emergency phone number

Your new telephone has three special speed dialling memories for emergency phone numbers, two of which are called "Police" and "Fire Dept" respectively. The emergency phone numbers applicable in your area should be stored here (e.g. 999). The third emergency phone number can be set individually by you, for example, the name and number of your GP. The emergency phone numbers can be called at any time and in any state of the handset via simple key combinations (refer to chapter 4.8 "Making an emergency call").

Emergency phone numbers are stored as follows:



Press **menu key**.



Select "**NAME/NO.**".



Press **OK key**.

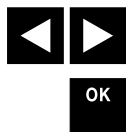

Select "**PROG. SOS-NO.**"

Press **OK key**.



Now select either one of the fixed numbers (Fire Dept., Police) or the number (Name) to be designated individually.



Confirm by pressing **OK key**.

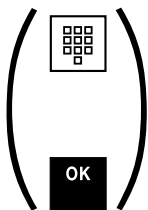

Now enter the name for the individual number.



Confirm by pressing **OK key**.



Enter the phone number.



Corrections can be made at any time by using the **left arrow key**.



Press **OK key**.

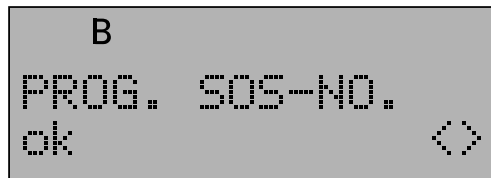

4.5 Deleting the speed dialling memory



Press **menu key**.



Press **OK key**.

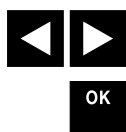

Select "**NAME/NO.**".

Press **OK key**.

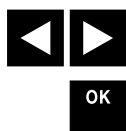

Select "**DEL. NAME/NO.**".

Press **OK key**.



Selection of memory location:

The memory location can be selected with the aid of the **arrow keys** or by entering the **two digit number**.



Press **OK key**.
Memory location is deleted.

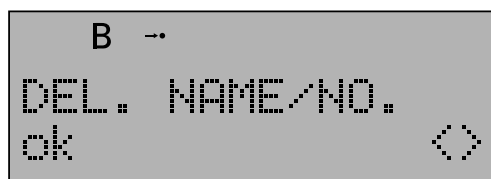

You can now delete a further speed dialling memory or quit this mode by pressing the **menu key**.

You can also **delete all speed dialling memories in one go**. Select "**DELETE ALL**" instead of "**DEL. NAME / NO**" and then press the **OK key** twice.

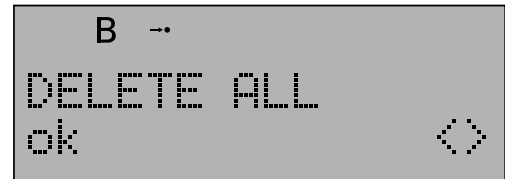

4.6 Speed dialling

The handset is in standby mode.



You can access the first/last speed dialling memory immediately via the **arrow keys**. ◀: 21, ▶: 01

A speed dialling memory can be selected selectively via the following procedure:



Press the **speed dialling key**.



The phone number is selected either by entering the **memory location number** (01...21) via the **keypad** or by "browsing" in the memory with the aid of the **arrow keys** or the **speed dialling key**. The corresponding name entry is displayed.

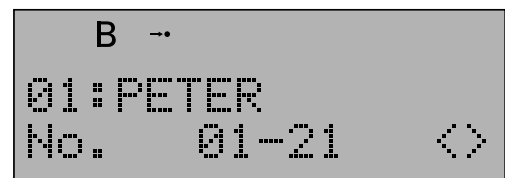

The corresponding phone number is displayed after pressing the **OK key**. The correction/suffix possibilities correspond to those available during manual dialling or number redial.

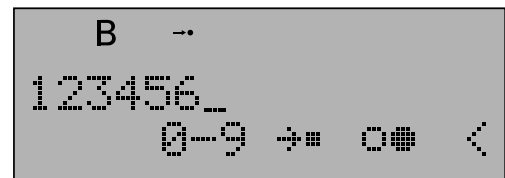





Press the **ON/OFF key** if you wish to dial the displayed phone number.

Only the last 15 digits of longer phone numbers are displayed.



4.7 SOS number (emergency numbers) - making an emergency call

It is always possible to dial one of the two fixed (Police, Fire Dept.) and one freely programmable emergency phone numbers (refer to chapter 4.4). An emergency call is made in the following way:

-  Press **menu key**.
-  Press numerical **key 1**.
-  Use the **arrow keys** to select the name.
-  A radio link is automatically established by pressing the **ON/OFF key** and the emergency phone number is dialed.



4.8 Muting

The telephone's microphone is switched off via the mute key. The person at the other end of the line cannot hear you.

-  Press **menu key**.
-  Press numerical **key 0**.
The microphone is switched off; **"MIC OFF!"** appears on the display for 3 seconds.



You can now talk to a person in the room without the person at the other end of the line being able to listen.

-  Press **menu key**.
-  Press numerical **key 0**.
The microphone is switched on again; **"MIC ON!"** appears on the display for 3 seconds.

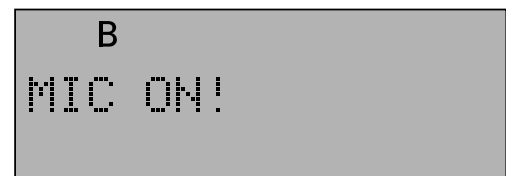

4.9 Switching on/off the handset

You can switch off your handset if you...

- for example, do not wish to be disturbed by incoming calls or
- are outside the range of the base station and want to spare the batteries.



The phone is switched off by keeping the **ON/OFF key** depressed for 2 seconds. "**POWER OFF**" appears on the display when it is switched off.



Press the **ON/OFF key** again to switch it back on.

Incoming calls are no longer signalled when the handset is switched off!

4.10 Temporary switching off of the handset

If you do not wish to or cannot take an incoming call at the moment, you can switch off the current ringing by pressing the STOP key!

4.11 Activating the keyboard lock



Press **menu key**.



Press **asterisk key**.

```

B
KEYBOARD OFF!
  
```

4.12 Deactivating the keyboard lock



Press **menu key**.



Press **asterisk key**.

```

B
KEYBOARD=OFF
*=On
  
```

4.13 Activating the handset lock / changing the PIN

The handset can be protected against unauthorised use by giving it a new PIN.

If the handset is given a new PIN as described below, then outgoing calls can only be made if the PIN has been entered beforehand.

The handset is in standby mode:



Press **menu key**.

Press **OK key**.

Select **"TEL.-LOCK ON/OFF"**.

Press **OK key**.

Enter new "personal" PIN
(e.g.: 1234) (default = 0000).
Enter PIN once again.

Press **OK key**.

The handset is now "locked". The PIN has to be entered first if an outgoing call is to be made.

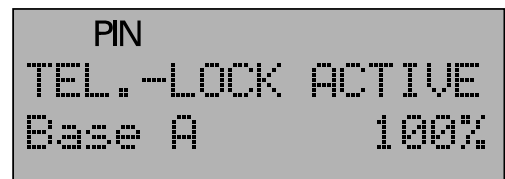

Please make a mental note of your new "personal" PIN. The handset will have to be "unlocked" by our Service if you should forget this PIN.

4.14 Phoning with active handset lock



Press the **ON/OFF key**.



Enter the PIN
(e.g.1234).
The following appears after a
correct entry:



Select the desired phone number.

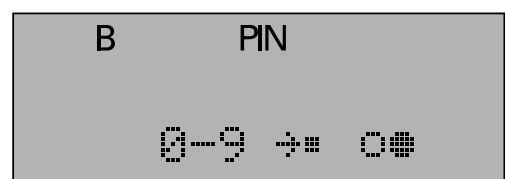
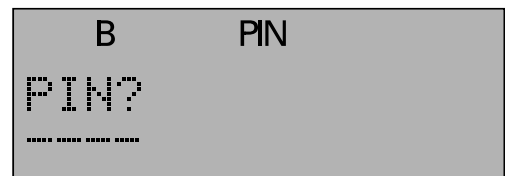

4.15 Deactivating the handset lock

The handset is in standby mode:

Press the **menu key**.

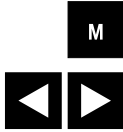

Select "TEL.-LOCK ON/OFF".

Press **OK key**.



Enter PIN
(e.g.: 1234).



Press **OK key**.
The handset lock has now been deactivated.

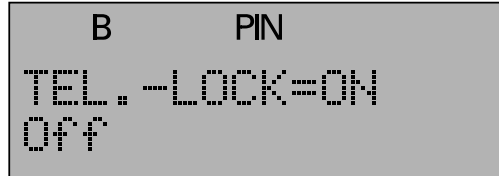

4.16 Call duration display

Time metering begins 10 seconds after the last digit of an external phone number has been dialled. The current duration of the call appears on the display in minutes and seconds after the first minute has elapsed.



4.17 Temporary (intermittent) changeover of signalling method

When pulse dialling is set, this changeover is necessary for example, for polling (remote interrogation of an answering machine) or for transmitting information to a pager or voice mailbox.

Existing connection or during dialling procedure:



Press the **asterisk key**.
If "DTMF" is set, the  symbol appears on the display.

Continue dialling.

Switch back by

- Terminating the connection.

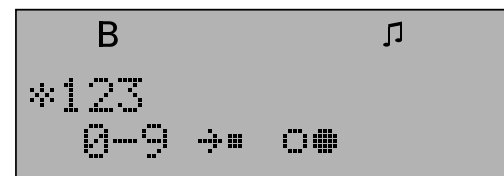

For a permanent changeover of the signalling method

proceed as described in chapter 7.1 "Setting the signalling method and dial pauses".

4.18 Changing the PIN (personal identification number) of the base



The personal identification number (PIN) protects important settings against **unauthorised** changes. You should program your **own PIN** to obtain an effective protection. Make a mental note of this PIN. A reset to the dispatch state "0 0 0 0" can **only** be carried out **by our Service**.







The handset is in standby mode within the range of a connected base:

- 
 Press **menu key**.
- 
 Press **OK key**.
- 
 Select "**SYSTEM**".
- 
 Press **OK key**.
- 
 Select "**PROG. PIN**".
- 
 Confirm with **OK key**.
- 
 Enter current PIN (0 0 0 0 in dispatch state), each digit deletes a dash "----".
- 
 Enter new PIN (four digits, numbers 0-9 possible).
- 
 Enter the new PIN once again and finish by pressing the **OK key**. It is possible to enter the new PIN again in the event of an input error.
- 
 Press **menu key**, the handset is in standby mode.

Note Programming can be aborted at any time by pressing the **menu key**.

5.1 Activating/deactivating the key click





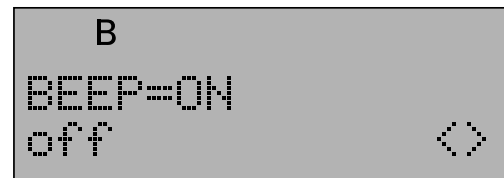

The key click is an acoustic acknowledgement of the operation of a key. The key click is switched on in the dispatch state; it can be switched off or on (depending on the current state) by carrying out the following steps.

-  Press **menu key**.
-  Press **OK key**.
-  Select "**SET UP**".
-  Press **OK key**.
-  Select "**BEEP=ON**" or "**BEEP=OFF**".
-  Press **OK key**.
-  Press **OK key**.
- Press **menu key** or select another menu item.



5.2 Setting the ringer

The **melody** and the **volume** of the ringer for **incoming calls** can be changed individually. 10 melodies and 8 volume settings are available. For example, a single tone sounds when the volume is set at level "01", in order to avoid any disturbance during a meeting. The following settings are set on delivery: volume: 05 melody: 02.

-  Press **menu key**.
-  Press **OK key**.
-  Select "**VOLUME/MELODY**".
-  Press **OK key**.
-  Select "**VOLUME**" or "**MELODY**".
-  Press **OK key**.
-  Adjusting the **volume**:
8 levels: 00 - ringer off / 01 - short click / 02...07 - volume
- Adjusting the **melody**: 10 melodies: 01...10.



OK

Press **OK key**.

M

Press **menu key**.

5.3 Increasing the handset volume

The standard preset volume of the handset can be increased. The display reads "volume high" or "volume standard" for three seconds after the changeover.

M

Press **menu key**.Press **hash key**.

B



VOLUME HIGH!

5.4 Resetting the handset volume to the standard volume

M

Press **menu key**.Press **hash key**.

B

VOLUME STANDARD!

6.1 Measuring the field strength

It is possible to measure the field strength, thus making it easier to select a (different) location.

The connection quality to the (up to three) most powerful base stations is displayed (if available).

M

Press **Menu key**.

5

Press **numerical key "5"**.

```

B
BASE A   KE1 KE2
RSSI: 95  00  00
  
```

The three most powerful base stations (if available) are indicated on the upper line. Their field strength is stated on the bottom line. An insufficient field strength is indicated by two zeros. This function is quit by pressing the **menu key**.

6.2 Selecting a base station

The handset can be logged into up to four base stations (A,B,C,D).

Your handset can thus be used in different places.

If you have changed your location, select the appropriate base station or let the system select the most favourable base for you with the aid of the "AUTO" function.

Please bear in mind that the handset can only make an "automatic" selection between bases into which it was logged beforehand. The base with the most powerful signal at the present moment is selected.

M

Press **menu key**.

OK

Press **OK key**.



Select **"SET UP"** with the arrow keys.

OK

Press **OK key**.



Select **"NEW BASE"**.

OK

Press **OK key**.



Select desired base (e.g.: A, B ...) or

```

NEW BASE
ok
  
```

```

BASE A
ok
  
```

Select "**AUTO**".



Press **OK key**.

Select further menu item or quit the menu by pressing the **menu key**.

6.3 Logging a handset into a base station

In order to make a call with the handset, it has to be logged into a base station. Necessary data is retrieved from the base station during the log-in procedure. In order to log the handset into a base or a base system, it is necessary to carry out a certain programming procedure both on the handset and also to prepare the base/base system for the log-in procedure.

1. Commence log-in on the handset:



Press **menu key**.



Press **OK key**.



Select "**SET UP**" with the arrow keys.



Press **OK key**.



Select "**NEW BASE**" with the arrow keys.



Press **OK key**.



Select desired base (e.g.: A, B ...). **Do not select "AUTO"!**



Press **OK key**.



Select "**LOG IN**" in "**SET UP**".



Press **OK key**.



Enter current PIN (dispatch state: 0 0 0 0).

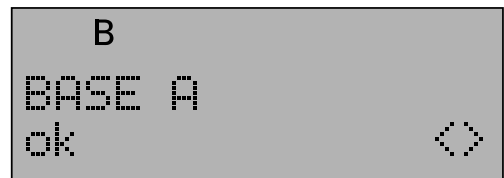

2. Necessary preparation of the base:

Disconnect the base station from the mains for a short while. After having been plugged in again, the base station is then ready to carry out the log-in procedure for a new handset for the duration of 30 seconds.

3. Continue log-in procedure on the handset:

<div style="background-color: black; color: white; padding: 2px 5px; display: inline-block; margin-bottom: 10px;">OK</div> <p>Now press the OK key. The log-in procedure can take a few seconds.</p>	<div style="border: 1px solid gray; background-color: #cccccc; padding: 10px; text-align: center; width: fit-content; margin-bottom: 10px;">LOG IN!</div>
<div style="border: 1px solid gray; background-color: #cccccc; padding: 2px; display: inline-block; margin-bottom: 10px;">  </div> <p>Enter one of the displayed free numbers as an (internal) phone number for the new handset.</p>	<div style="border: 1px solid gray; background-color: #cccccc; padding: 10px; text-align: center; width: fit-content; margin-bottom: 10px;"> B --2345678 </div>
<div style="background-color: black; color: white; padding: 2px 5px; display: inline-block;">OK</div> <p>Terminate the log-in procedure by pressing the OK key.</p>	

6.4 Logging in an additional handset (Multilink)

Up to 8 handsets can be logged into a base station. Outgoing calls can be made from all handsets. Incoming calls, however, are signalled and can be answered by the first four handsets (-1-, -2-, -3- and -4-) only.

The log-in of a new handset is carried out from this very handset (refer to chapter 6.3).

If handsets from other manufacturers are to be logged in, please refer to their operating instructions.

6.5 Logging off a handset (Multilink)

A handset can be logged off from any of the handsets that are currently logged in. However, this handset cannot log itself off.

The handset is in standby mode:

- M

 Press **menu key**.
- OK

 Press **OK key**.



Select "**SYSTEM**".



Press **OK key**.



Select "**LOG OUT**".



Press **OK key**.



Enter current PIN:
Display of the logged-in handsets.



Enter the (internal) number of the handset which is to be logged off.



Press **OK key** and **Menu key**.

6.6 Consultation hold/extending calls to another handset (Multilink)

During an internal or external call:



Press **INT key**.



Enter the number of the desired handset.

Terminate consultation hold



Press **INT key** or **R key**.

or

Transfer the call:



Press **ON/OFF key**.

Notes











An incoming external call during an internal connection is signalled to these handsets by a "Camp-on (call waiting) tone". "Free" handsets ring in a normal way. The subscribers making the internal call have to terminate their conversation (ON/OFF) to be able to take the external call and must await the external call ring. The external call can then be taken by pressing the ON/OFF key.

A consultation hold to a further external line is not possible.



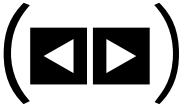

7.1 Setting the signalling method and the dial pauses

The signalling method, the flash time of the "R" signal key and the dial pause can be set as required. For further details, please refer to the overview of the menu items. Pulse dialling (PULSE is preset) or the quicker dual tone multi-frequency signalling (DTMF) can be used. For use on a PABX select the menu item PUBLIC/PABX (PUBLIC is preset).

The handset is in standby mode:

-  Press **menu key**.
-  Press **OK key**.
-  Select "**SYSTEM**".
-  Press **OK key**.
-  Select "**MODE**".
-  Press **OK key**.
-  Select the desired setting from the menu.
-  Press **OK key**.
-  Select further settings.
- or:
-  Terminate the procedure by pressing the **menu key**. The handset returns to standby mode.

7.2 Extending a call / consultation hold within a telephone system

-   **During a call:**
Press the signal key. Dial the number of the desired extension.
-  **Extending:**
Announce the call and press the "ON/OFF" key when the other extension has answered; the call has then been transferred.
-  **Terminating consultation hold**
Press the signal key. You are then reconnected to the first caller.

Note Only possible when "DTMF" is set.

8.1 General information

As the Pico system is a GAP-compliant unit, handsets from other manufacturers can be operated on the Pico base (provided they too are GAP-compliant).

If the handset in question has an **INT key** and if you have access to the service menu, then it is even possible to operate the system settings of the Pico base (e.g. changeover of the signalling method etc.).

If this is the case, then proceed as follows:

- Use your handset to dial into the system menu (refer to the operating instructions for your handset).
 - Either "##" or "--" will now appear on the handset display (depending on the type of display).
- You can now select one of the available functions from the following list:

Changing the base PIN	• 97	enter current PIN enter new PIN twice
Setting signalling method	• 20 • 22	pulse dialling or 88 ms DTMF flash key
Logging off handset	• 40	enter current PIN enter the internal number of the handset
Setting dial pauses	• 24 • 25	dial pause (approx. 3 sec.) after the first digit or delete dial pause and enter current PIN

The procedure is terminated by pressing the **INT key** and interrupting the connection (replacing the handset).

Pictograms in the display

8 different pictograms help you to operate the phone.

B

Availability display - logged in and within the range of private base stations.



Activated when microphone is switched off (mute).



Activated: when pressing the  key to select a number redial phone number during dial preparation (History function).

Deactivated: during retrieval of a telephone number, termination or abortion of a procedure.



Activated: when pressing the  key to select/program a speed dialing number.

Deactivated: during retrieval of a phone number, termination or abortion of a procedure.

PIN

Activated when the handset lock is switched on against unauthorized use.



Activated when DTMF signalling is set - this pictogram is controlled by the base!



Activated when the volume is set to HIGH (loud).



Activated when the keyboard lock is switched on.

Cleaning and care

Simply wipe the plastic parts with a slightly moistened cloth or an antistatic cloth; do not use a dry cloth and avoid using cleaning or scouring agents.

Technical data

Standard:		DECT GAP
Transmit / receive frequency:		1880 - 1900 MHz
Range:		up to 300 m (up to 50 m in buildings)
Power supply:		Base station 230 V _~ / 50 Hz, 11 VA (plug-in power supply unit)
Operating time (with fully charged batteries 2x700 mAh):		in stand-by: up to 40 hrs (typ.) making a call: up to 4 hrs (typ.)
Recommended ambient conditions:		+15° C - +35° C / 20% -75% rel. air humidity
Signalling method:		Pulse dialling / DTMF; Flash key, 88 ms
Dimensions:	Base station Handset	WxHxD = 86 x 50 x 178 mm WxHxD = 53 x 150 x 24 or 28 mm (Depth depends on the battery cover used)
Weight:	Base station Handset	300 g 160 g
Length of the connecting cable:		3 m mains cable for base station 3 m telephone connecting cable
Connector plug:	Telephone line Mains cable	national plug, western plugs on the device plug-in power supply unit with national plug western plugs on the device
Storage temperature:		0° C - +55° C

Faults and remedies

- No function
 - ⇒ Battery empty → charge battery make sure that the batteries are seated correctly/the contacts are clean.
(refer to 1.4)
 - ⇒ Log in the handset.
(refer to 6.2 and 6.3)
 - The battery state is not displayed
 - ⇒ The batteries have been replaced (display only after 60% of the capacity has been attained)
→ charge battery
(refer to 1.3)
 - No outgoing dialling possible
 - ⇒ wrong signalling method set
(refer to 7.1)
 - No dialling tone
 - ⇒ Connecting cable not plugged in correctly/telephone and mains terminals mixed up
(refer to 1.2)
 - Signal key does not operate correctly
 - ⇒ The signal key does not have a function in the system used
 - No signalling during dual tone multi-frequency signalling (DTMF)
 - ⇒ The extension or local exchange does not support dual tone multi-frequency signalling
(refer to 7.1)
-

-
- A**ccessories.....3
 - Approval35
 - Arrow keys8
 - B**asic settings6
 - Batteries5-6
 - Battery handling.....5
 - C**all duration13
 - Call duration display23
 - Camp-on tone7
 - Care.....34
 - CE label.....35
 - Changing the PIN22
 - Characters9
 - Charging batteries.....5
 - Cleaning.....34
 - Confirmation tones.....7
 - Connection4
 - Consultation hold.....31
 - Consultation hold/extending30
 - D**ECT standard.....3
 - Delivery state6
 - Dial pauses31
 - Dial preparation.....12
 - Displays11
 - E**mergency phone number.....17, 20
 - En-bloc dialling.....13
 - Encryption.....3
 - Extending a call31
 - External call13
 - F**aults and remedies39
 - G**AP standard,3
 - H**andset lock.....22-23
 - Handset volume.....26
 - Hearing aids.....3
 - History function15
 - I**nternal call.....14
 - K**ey click.....25
 - Keypad7
 - Keyboard lock.....21
 - L**ogging a handset into a
 - base station.....28
 - Log-in.....28
 - Logging in an additional
 - handset (Multilink).....29
 - Logging off.....29
 - Logging off the handset.....29
 - M**aking an emergency call.....20
 - Measuring the field strength.....27
 - Menu items – base station37
 - Menu items – handset.....36
 - Menu key.....8
 - Multilink29
 - Muting20
 - N**ames9
 - Number redial12, 15
 - OK** key.....8
 - Operating overview7
 - Overviewfront cover
 - Overview of the menu items –
 - base station41
 - handset.....40
 - P**ictograms.....33
 - PIN.....3, 24
 - Power failure3
 - R**eady-to-dial mode.....11
 - Replacing batteries15
 - Ringer25
 - Ringer signals7
 - S**electing a base station.....28
 - Selecting the location4
 - Service.....40
 - Signalling method31
 - SOS number.....17, 20
 - Speed dialling19
 - Standby mode11
 - Stop key8
 - Switching off the handset.....21
 - Switching on13
 - T**aking a call.....14
 - Technical data.....34
 - Temporary changing over
 - of the signalling method23
 - Temporary switching off.....21
 - Terminating a call14
 - Texts9
 - Time-Out.....7
-

The product complies with the basic requirements of all respective directives of the European Union Council. The specified conformity assessment procedures were performed.

CE 0188 X for the portable part

The portable part meets the requirements of the following EU directives:

CTR 6 (97/523/EG) (Edition II)

CTR 10 (97/524/EG) (Edition II)

CTR 22 (97/525/EG) (Edition I)

EN 50081-1 (01/92)

EN 50082-1 (01/92)

ETS 300 329 (06/97)

EN 60950-A4 (07/96)

EN 41003 (03/93)

CE and BABT certificates for the fixed part

The fixed part meets the requirements of the following EU directives:

British Standard PD 6568 / 92

British Standard PD 6569 - Part 1 / 92

British Standard PD 6569 - Section 3.1 / 92

NET 4 [ETS 300 001 - 08/92]

CTR 6 (97/523/EG) [Edition II]

CTR 10 (97/524/EG) [Edition II]

CTR 22 (97/525/EG) [Edition I]

EN 50081-1 (01/92)

EN 50082-1 (01/92)

ETS 300 329 (06/97)

EN 60950-A4 (07/96)

EN 41003 (03/93)

Safety information

This product may be used legally only in a country where the appropriate authority has given its specific authorisation. This authorisation appears on the BABT-label at the back of the base station.

Power requirements

This product requires an electrical supply of 230 volt / 50Hz, alternating monophased current, excluding (IT) installations defined in the standard EN 60950.

Warning!

The electrical network is classified as excessive according to criteria in the standard EN 41003.

The only way to power down this product is by unplugging the power cable from the electrical outlet. Make sure the electrical outlet is located close to the apparatus and is always easily accessible.

It is recommended that this telephone be used as a complement to another telephone which does not require mains power.

Telephone connection:

The voltage on this network is classified as TNV (Telecommunication Network Voltage) and the voltages presented on the RJ11-connection (Western-plug) are classified TNV (Telecommunication Network Voltage) and SELV (Safety Extra Low Voltage), as defined in the standard EN 41003

Safety precautions:

Do not allow the handset to come into contact with water. Do not open handset or the base station. This could expose you to high voltages. Contact our after-sales service for all repairs.

- Do not allow the charging contacts or the battery to come into contact with conductive materials such as keys, paper clips, rings, bracelets, etc. Use your Battery Backup Power Supply Unit only according the „**Instructions for Use**“

Instructions for use of Battery Backup Power Supply Unit

- a) The HomeHandy Pico is suitable for connection to the PSTN circuits in the U.K.
 - b) The HomeHandy Pico has a ringer equivalence number (REN) of 0. That is you can connect the HomeHandy Pico simultaneously to the line with all
-

the apparatus you have connected before, provided that you have paid attention to the rule that the sum of all RENs may not exceed four. Otherwise it is not guaranteed that all apparatus will ring correctly.

- c) You can use the HomeHandy Pico on PSTN lines with loop-disconnect or multi-frequency dialling.
- d) A call cannot be made with the HomeHandy Pico during a mains failure because the power supply to the base station is then interrupted.

In case of mains failure all functions of the HomeHandy Pico will be preserved for a minimum of 7 hours if the battery backup is installed. During the 7 hour period you have the possibility of communication for at least 1 hour.

General

- Replace the batteries after a mains failure has occurred
- Replace the batteries once a year
- Use 6 AA cells with 1,5 Ah
- Do not use rechargeable batteries

Installation of battery backup

- Place the batteries in the battery holder, paying attention to the polarity
- Plug the power supply into the battery backup
- Connect the base station

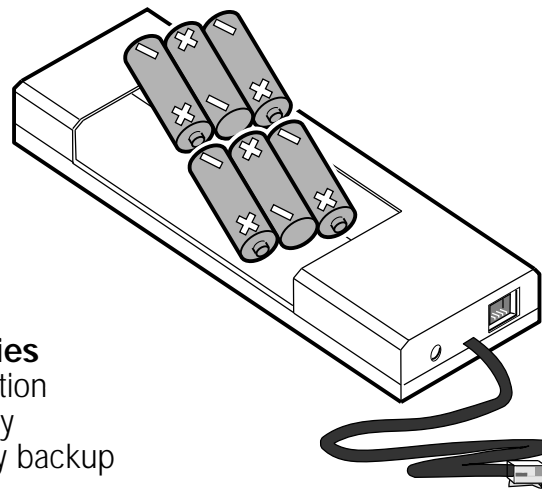

Replacement of batteries

- Disconnect the base station
- Unplug the power supply
- see installation of battery backup

Note: For best availability of BT emergency (999) service it is recommended that you connect the HomeHandy Pico together with another telephone (that needs no external power source to provide the simple telephone functions) to the telephone network.

Overview of menu items – handset

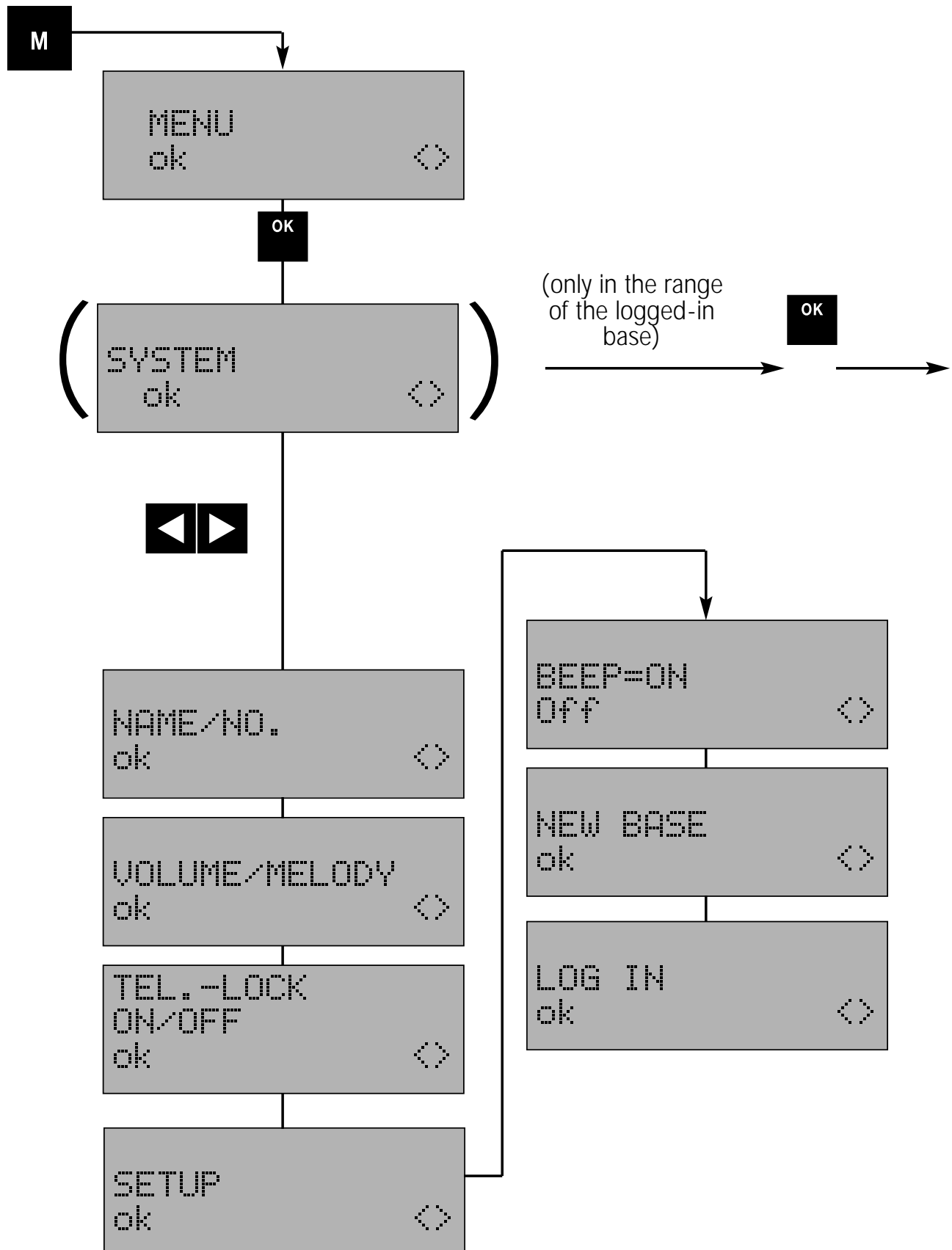

Overview of menu items - base station

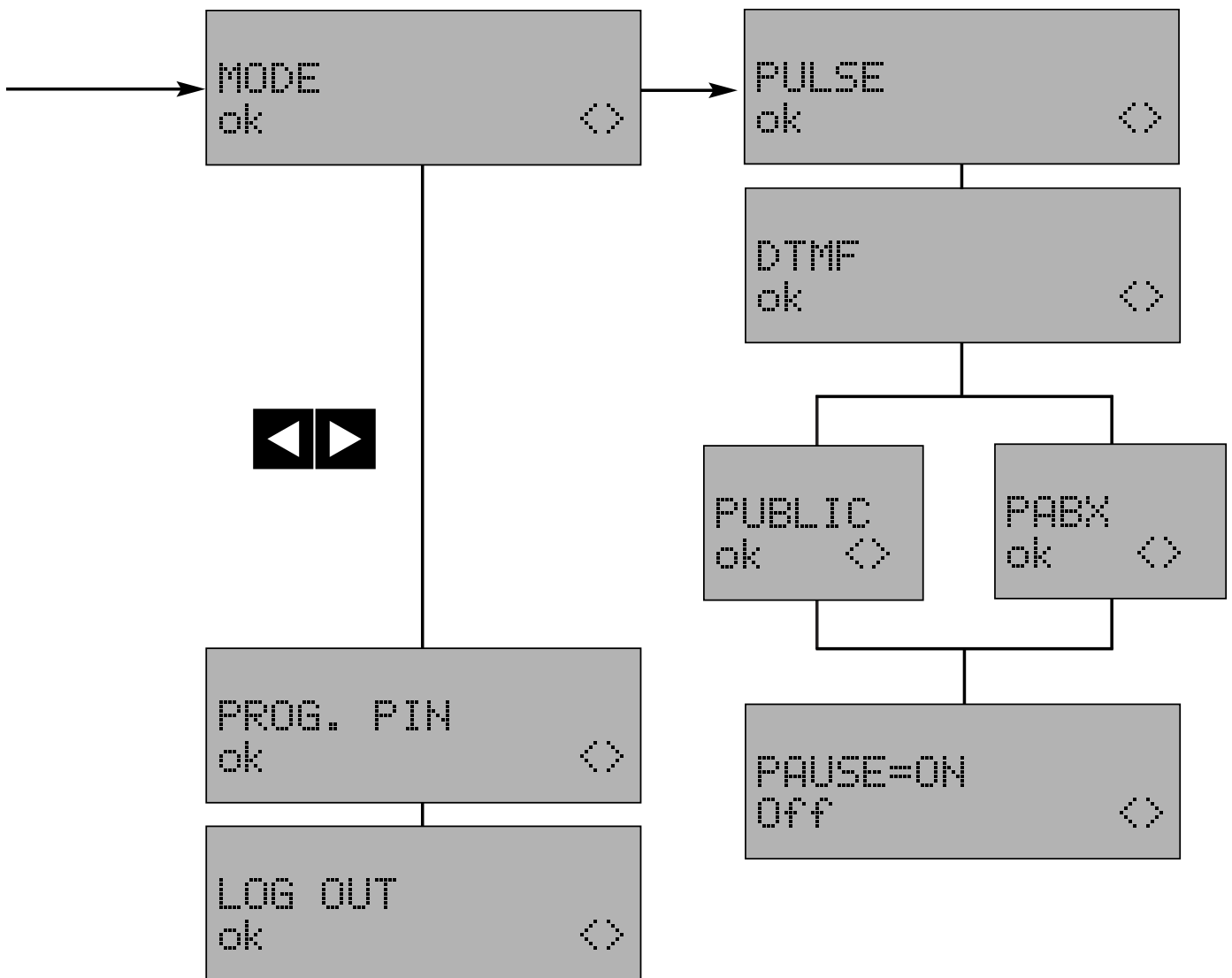

Technical specifications subject to change

Hagenuk Telecom GmbH
Westring 431
D 24118 Kiel

Operating instructions for HomeHandy Pico
Mat. No. 3027.034
Edition 12.10.98

Dear customer,

should your telephone develop a malfunction, we kindly ask you to check, with the aid of the chapter "Faults and remedies" in the operating instructions, whether there actually is a defect before sending in the device. Please also make use of our technical hotline.

Hagenuk Customer Services Tel.: 01767 654400

Sometimes it is possible to switch the device to a defined serviceable state by removing the battery for a short time and disconnecting the mains plug.

Sender

Device bought at

Name: Store:

Address: Address

Telephone: Purchase date:

Please characterise and describe the fault below using your own words (also on the reverse side if necessary). This helps us to reduce the repair time. Please make a note of the "S Nr...." on the underside of the base station for any queries which should arise.

- Connection setup handset / base station OK, no trunk tone audible
- No connection setup (handset beeps / antenna symbol flashes)

Acoustics

- Listening distance
- Speaking distance
- Dead
- Too quiet
- Too loud
- Noise / Interference

Tone ringing handset

- Without function
- Too quiet
- Too loud

Display

- Missing characters
- Wrong characters
- No display

Incorrect dialling

Defective battery charging

Miscellaneous (please describe the fault as exactly as possible):

.....
.....
.....